

Data Sheet



Article number: 0105047

Description: Retaining ring AV 30

Note: Fitted with ZGA pliers

Measures

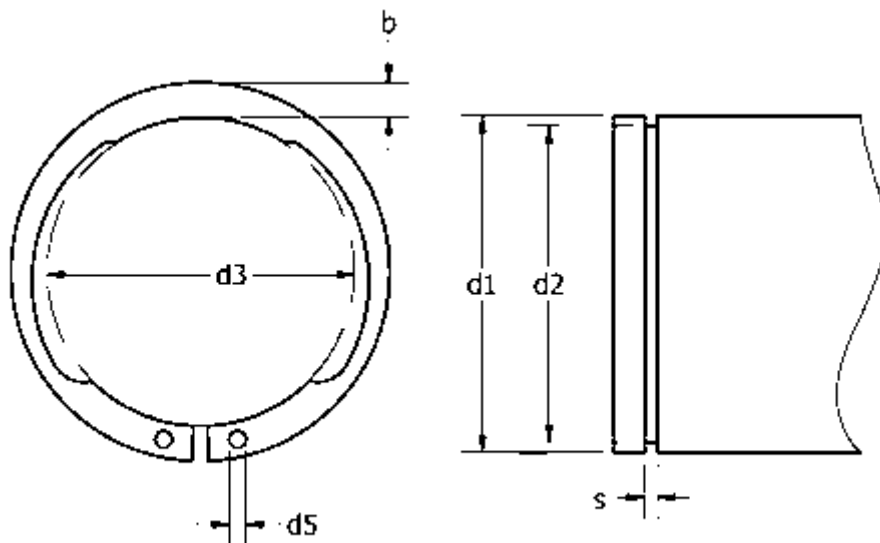

AN mm ²	= 29.2	FRg kN	= 6.3	t	= 0.70
b	= 3.9	FR kN	= 27.5	tol	= -0.06
d1	= 30	g	= 1.5	tol	= -0.21
d2	= 28.6	K kN-mm	= 53.5	tol	= +0,21-0,42
d3	= 27.90	m min	= 1.60	tol	= 0.1
d5 min	= 2.0	n abl x 1000	= 19	Tong	= ZGA-2
Description	= AV 30	s	= 1.50	Weight kg/1000	= 3.58
FN kN	= 4.86	Side power N at I2	= 2.1		